

Fan Coil EC Motor Control

G3 PWM BOARD

The Titus “Generation 3 PWM” (G3 PWM) board provides a pulse-width modulated (PWM) signal to the EC motor to control fan speed. The board is factory programmed to control the motor in either Three Speed (adjustable) mode or Proportional Control using a remote 2 – 10 V DC input signal. In Proportional Control mode, a 2 – 10 V DC signal will control EC motor speed between factory set minimum (Min) and maximum (Max) values. For either control mode, fan on/off control is enabled via the ‘G’ signal.

Tools Needed:

- Digital multimeter capable of measuring 30 volts AC/DC and duty cycle
- Insulated 1/8” flat bladed screwdriver
- Mini Hook Test Clips for multimeter (optional)

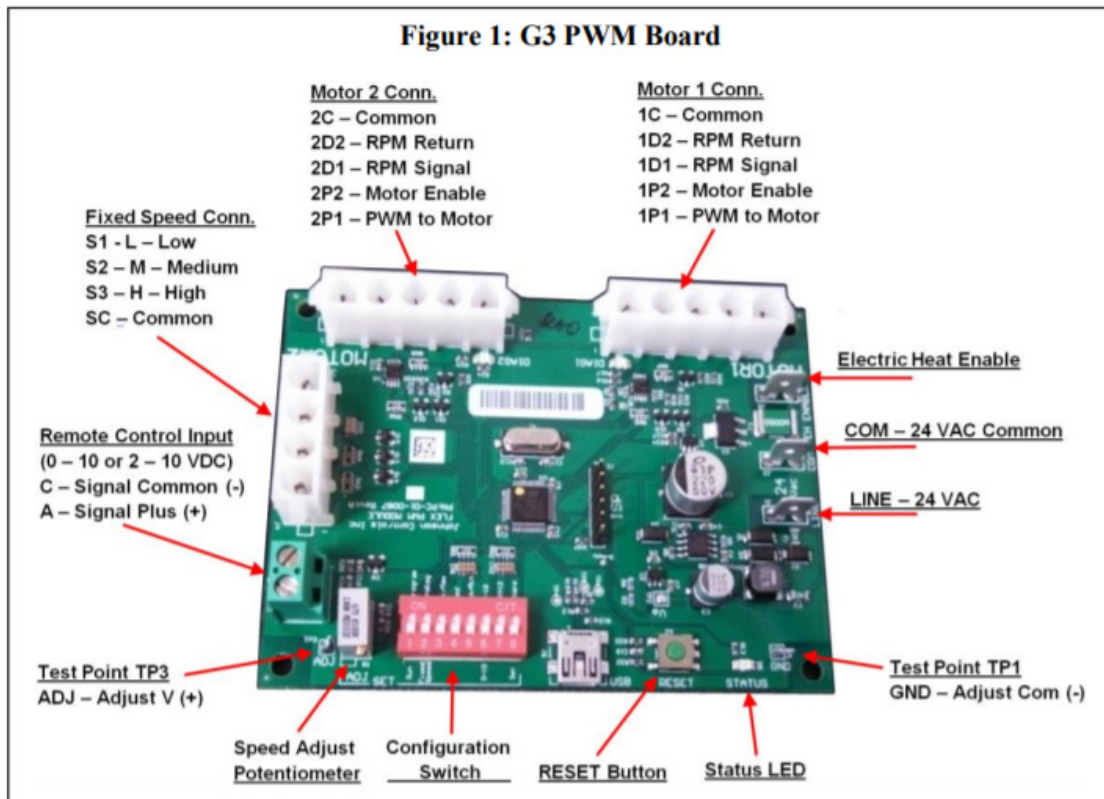

PWM BOARD STATUS LED

The G3 PWM Status LED (refer to Figure 1) indicates the status of the G3 PWM board. See Table 1, below.

TABLE 1 - G3 STATUS LED DEFINITION		
Flash	Mode	Indicates
Yes	Run	Normal
Yes	Program	Timed Out
Always On	Run	Error
Always On	Program	Program Mode
Always Off	Any	Fault

Fan Coil EC Motor Control

G3 PWM Status Descriptions

Normal - (Run mode) - If configuration switch 1 is in Run Mode (OFF) the LED will flash to indicate Normal status.

Timed Out - (Program Mode) - The PWM board has a time out function in Program Mode. If the PWM board has timed out in Program Mode, the LED will flash. Time Out may be cleared by pushing the Reset Button.

Error - (Run Mode) - If configuration switch 1 is in Run mode (OFF) and the LED is always ON, there is a system error. Verify all connections and proper input voltage at Line and Com, then push the Reset Button. If this fails to return the board to Normal mode, replace the board.

Program Mode - If configuration switch 1 is in Program Mode (ON) the LED will be always ON to indicate that the board is in Program Mode. See Figure 2, below.

NOTE: While in Program Mode, the fan motor will not run.

Fault - (Any mode) - If the LED remains OFF, the board either has no power or is faulted. Verify proper input voltage at Line and Com, then push the Reset Button. If this fails to return the board to expected mode, replace the board.

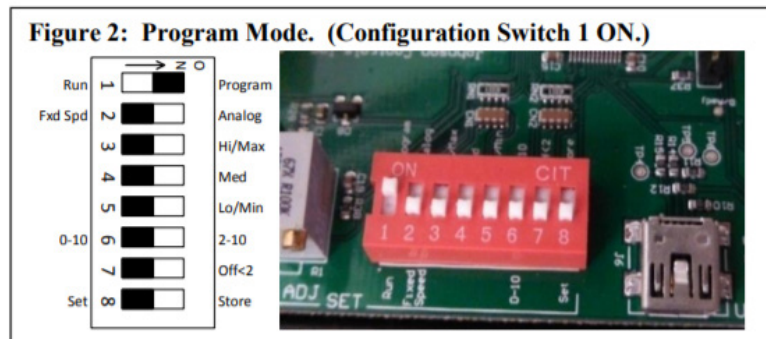

BALANCING UNITS WITH EC MOTORS

ELECTRICAL SHOCK HAZARD. All power must be disconnected prior to installation and servicing this equipment. More than one source of power may be present. Disconnect all power sources to avoid electrocution or shock injuries. Refer to lock out tag out procedures.

1. Make sure there are no obstructions in the discharge ductwork and/or at the plenum opening.
2. Locate the G3 PWM board in the control enclosure. Refer to Figure 1 for location of test points TP3 and TP1, the Configuration Switch, Speed Adjust Potentiometer, and Reset Button.
3. Place Configuration Switch into Program Mode. Use an insulated screwdriver to flip configuration switch #1 (closest to speed adjust potentiometer) to the ON position. See Figure 2.
4. Press Reset button. Connect a voltmeter to test points TP1 (-) and TP3 (+). Refer to Figure 1. Set voltmeter to DC volts.

NOTE: The PWM board must be in Program Mode to read voltage across TP1 and TP3.

Fan Coil EC Motor Control

5. Apply power to the unit. Verify that the status LED is Always On, indicating that the PWM board is in Program Mode. If the status LED blinks while in Program Mode, the board has timed out. In this case, push the reset button and verify the status LED returns to Always On.

NOTE: The PWM board times out in Program Mode after approximately 5-6 minutes and will need to be reset by pushing the reset button. If more time is needed to verify correct airflow, perform the STORE operation (through switch 8) after adjustment to save the adjusted fan speed.

6. Determine desired fan operating points. Refer to the Fan Calibration Curve label supplied on the side of the equipment. There are two different styles of Fan Calibration Curve, depending on EC motor type.

NOTE: The Fan Calibration Curve provided with the unit represents response for a unit with typical configuration. Actual airflow may vary slightly depending on actual system configuration.

a. Constant RPM and Constant Torque EC Motor. Refer to Figure 3a for sample label. Five curves are shown, showing factory default airflow for Minimum, Low, Medium, High, and Maximum speeds. A table is provided which shows the expected voltage across test points TP1 and TP3 for each speed, depending on whether the unit is set up for three speed or 2 – 10 VDC motor control.

b. Constant Airflow EC Motor. Refer to Figure 3b for sample label. Several curves are shown on the label, one for each size unit. Refer to the 0 to 2.5 volt scale on the label and use the voltmeter to read the voltage across TP1 and TP3 to determine desired airflow setting.

NOTE: Changing the factory setting for minimum and maximum CFMs will invalidate the range for the Fan Calibration Curve as it will narrow the scale of the input signal.

7. Follow instructions for adjusting EC motor speed using the G3 PWM board. Separate instructions are provided for Three Speed (adjustable) and 2 – 10 VDC Proportional motor control modes.

Figure 3a: Constant RPM and Constant Torque EC Motors Example Fan Calibration Curve

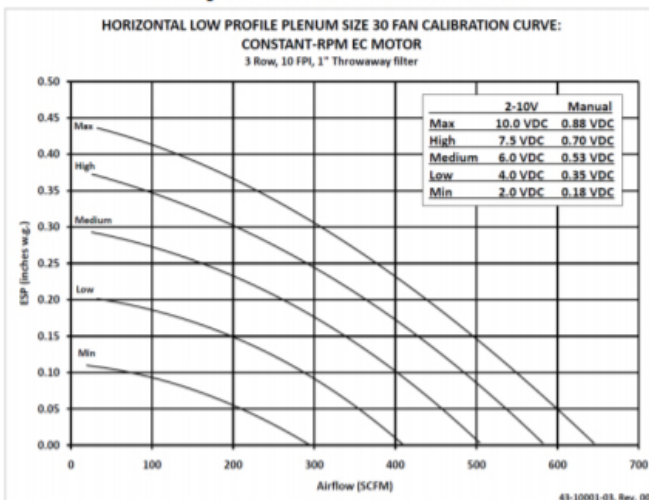
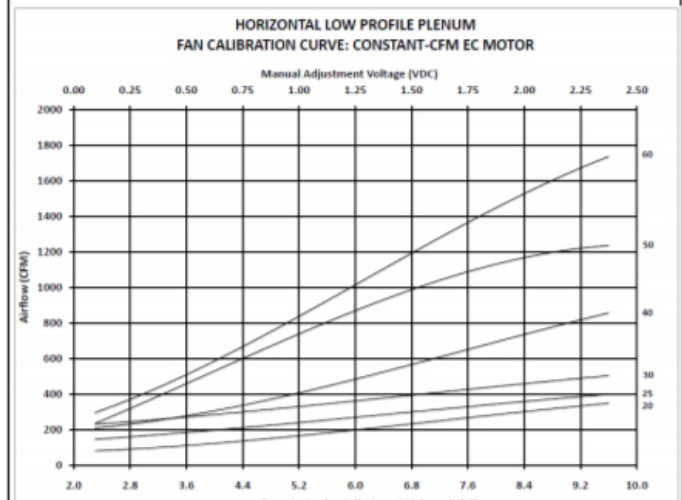

Figure 3b: Constant Airflow EC Motors Example Fan Calibration Curve



Fan Coil EC Motor Control

Adjusting EC Motor Speed

This section contains instructions for using the G3 PWM board to adjust the EC motor speed for balancing purposes. There are two modes of EC motor speed control: Three Speed operation at three fixed (adjustable) speeds, or Proportional Control with remote 2 – 10 VDC signal.

Warning! For units with electric heat, fan speed must not be adjusted below 70 CFM/kW.

Refer to Figure 1 for location of configuration switch, speed adjust potentiometer, and reset button. These will be used to program the EC operating mode and motor speed settings.

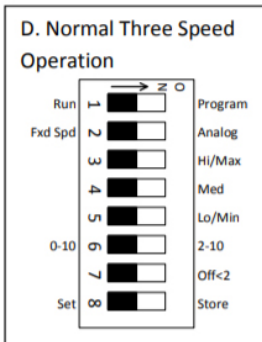
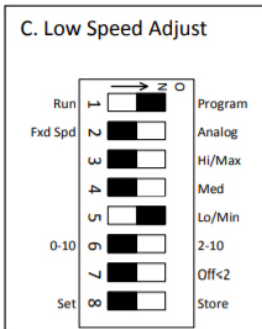
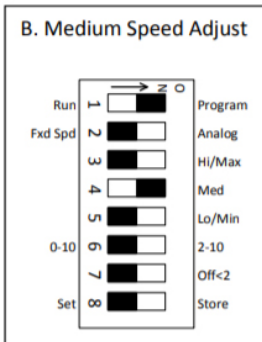
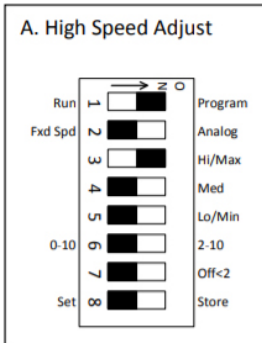

THREE SPEED (ADJUSTABLE) MOTOR CONTROL

High, Medium, and/or Low speed adjustment for three speed operation.

NOTE: Thermostat must be set for three speed operation

1. **High Speed Setting Adjust:** Set Configuration Switch to HIGH SPEED adjust (see figure A at left.) Switches to ON-OFF-ON-OFF-OFF-OFF-OFF-OFF.

- Set switch 1 to ON (Program)
- Set switch 2 to OFF (Fixed Speed)
- Set switch 3 to ON (Hi/Max)
- Set switches 4 through 8 to OFF
- **Press RESET button.** (Note: RESET button only needs to be pressed once per programming session unless board times out. Refer to Status LED.)

• Refer to voltmeter connected to TP1 and TP3. Using an insulated 1/8" flat bladed screwdriver, adjust speed potentiometer to desired high speed airflow per Fan Calibration Curve on unit.

- **STORE:** Set switch 8 to Store (ON), wait one second, then to Set (OFF), to save the value

2. **Medium speed Adjust:** Set Configuration Switch to MEDIUM SPEED adjust (see figure B at left.) Switches to ON-OFF-OFF-ON-OFF-OFF-OFF-OFF.

- Set switch 1 to ON (Program)
- Set switches 2 -3 to OFF
- Set switch 4 to ON (Med)
- Set switches 5 through 8 to OFF
- Refer to voltmeter connected to TP1 and TP3. Using an insulated 1/8" flat bladed screwdriver, adjust speed potentiometer to desired high speed airflow per Fan Calibration Curve on unit.

- **STORE:** Set switch 8 to Store (ON), wait one second, then to Set (OFF), to save the value

3. **Low Speed Adjust:** Set Configuration Switch to LOW SPEED adjust (see figure C at left.) Switches to ON-OFF-OFF-OFF-ON-OFF-OFF-OFF.

- Set switch 1 to ON (Program)
- Set switches 2 -4 to OFF
- Set switch 5 to ON (Lo/Min)
- Set switches 6 through 8 to OFF
- Refer to voltmeter connected to TP1 and TP3. Using an insulated 1/8" flat bladed screwdriver, adjust speed potentiometer to desired high speed airflow per Fan Calibration Curve on unit.

Fan Coil EC Motor Control

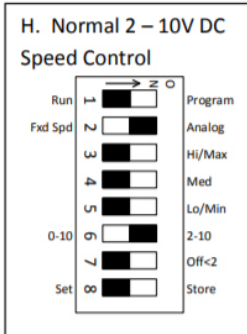
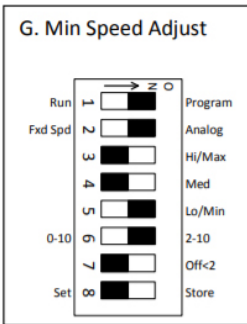
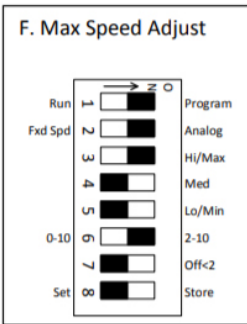
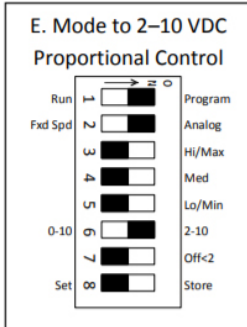

- **STORE:** Set switch 8 to Store (ON), wait one second, then to Set (OFF), to save the value
4. **Resume Normal Three Speed Operation:** Set all switches to OFF to resume normal three speed operation. Refer to figure D at left.

2 – 10 VDC PROPORTIONAL MOTOR CONTROL

Speed range adjustment for Proportional Control operation. Minimum (Min) and maximum (Max) speeds are programmed at the factory for optimum operation. Changing factory Min or Max speed defaults will change the motor effective speed range and invalidate the voltage settings shown on the Fan Calibration Curve. However, the speed range may still be adjusted as long as the Min speed remains greater than 70 CFM/kW for units with electric heat.

NOTE: Thermostat must be set for either analog or single (high) speed operation.

1. **Connections.** Connect or verify connection of remote analog signal and common wires to 2-10 VDC Remote Control Input terminals (refer to Figure 1.)

2. **Set Mode to 2 – 10 VDC Proportional Control:** Set configuration switches to 2 – 10 ANALOG programming mode (see figure E at left.) Switches to ON-ON-OFF-OFF-OFF-ON-OFF-OFF.

- Set switch 1 to ON (Program)
 - Set switch 2 to ON (Analog)
 - Set switches 3 – 5 to OFF
 - Set switch 6 to ON (2-10 V)
 - Set switches 7 and 8 to OFF
- **Press RESET button.** (Note: RESET button only needs to be pressed once per programming session unless board times out. Refer to Status LED.)
- **STORE:** Set switch 8 to Store (ON), wait one second, then to Set (OFF), to save the value.

NOTE: If adjusting Min/Max CFM values, continue to step 3. Otherwise, skip to step 5.

3. **Max Speed Adjust:** Set configuration switches to HI/MAX SPEED balancing mode (see figure F at left.) Switches to ON-ON-ON-OFF-OFF-ON-OFF-OFF.

- Set switch 1 to ON (Program)
 - Set switch 2 to ON (Analog)
 - Set switch 3 to ON (Hi/Max)
 - Set switches 4 and 5 to OFF
 - Set switch 6 to ON (2-10 V)
 - Set switches 7 and 8 to OFF
- Refer to voltmeter connected to TP1 and TP3. Using an insulated 1/8" flat bladed screwdriver, adjust speed potentiometer to desired Max speed airflow.
- **STORE:** Set switch 8 to Store (ON), wait one second, then to Set (OFF), to save the value

4. **Min Speed Adjust:** Set configuration switches to LO/MIN SPEED balancing mode (see figure G at left.) Switches to ON-ON-OFF-OFF-ON-ON-OFF-OFF

- Set switch 1 to ON (Program)
- Set switch 2 to ON (Analog)
- Set switches 3 and 4 to OFF
- Set switch 5 to ON (Lo/min)

Fan Coil EC Motor Control

- Set switch 6 to ON (2-10 V)
- Set switches 7 and 8 to OFF
- Refer to voltmeter connected to TP1 and TP3. Using an insulated 1/8" flat bladed screwdriver, adjust speed potentiometer to desired Min speed airflow.
- **STORE:** Set switch 8 to Store (ON), wait one second, then to Set (OFF), to save the value

5. **Resume Normal 2 – 10 V DC Proportional Control:** Set configuration switches to OFF-ONOFF-OFF-OFF-ON-OFF-OFF for normal proportional speed control, as shown at left in figure H.

- Set switch 2 to ON (Analog)
- Set switch 6 to ON (2 – 10)
- Set all other switches to OFF

EC Motor Troubleshooting Guidelines

Ensure motors and blowers are clean as part of normal maintenance. No further maintenance is required for these motors. Warning! Follow standard lock out tag out (LOTO) procedures when performing service on motor or blower.

EC MOTOR TROUBLESHOOTING GUIDELINES		
Problem	Possible Cause	Corrective Action
Motor fails to start	No or loose enable jumper (Big Best manufactured constant RPM motor only)	Verify enable jumper connected properly to motor driver. Refer to "Enable Jumper" section (page 12).
	No power to motor. Possible blown fuse or open circuit breaker	Verify line voltage at motor driver. Replace fuse or reset circuit breaker.
	PWM configuration switch in program mode	Configuration switch 1 must be in Run mode (page 2, figure 2). Refer also to PWM board status LEDs (page 1).
	PWM board faulted	Refer to PWM board status LEDs (page 1). Verify voltage input, wiring and connections. Push reset button. Replace PWM board if fault returns.
	No control signal (constant RPM)	Constant RPM EC motors will not rotate if they lose PWM signal while enabled. Verify PWM signal at motor connector by connecting a multimeter set for "duty cycle" between pins 1P1 and 1C (or between pins 2P1 and 2C). The duty cycle represents the on-time percentage signal sent to the motor (this number will vary between the minimum and maximum duty cycle set by the factory). See Figure 1 for PWM board connections (page 1). Refer also to PWM board status LEDs (page 1) to verify board is in normal operating mode.
	Improper wiring connections	Verify wiring. If Fan Coil Relay board present, verify all jumpers installed. Refer to Fan Coil Relay Board Troubleshooting Guide.
	EC motor wiring harness improperly seated	Unplug harness and re-install, making sure plugs are fully seated.
	EC motor wiring harness(es) open or intermittent	Replace harness(es). See section on checking wire harnesses (page 9).
	Blower jammed	Clear blockage. Verify blower rotates freely with motor disconnected.
	No 24 VAC power	Refer to Fan Coil Relay Board Troubleshooting Guide

Fan Coil EC Motor Control

EC MOTOR TROUBLESHOOTING GUIDELINES		
Problem	Possible Cause	Corrective Action
Motor fails to start	Float switch tripped	Verify float switch (if present) is made.
	Motor seized	Verify motor rotates freely by hand with blower disconnected. If not, replace motor.
	Damaged motor cable	Cable is integral to motor, replace motor
Motor surges	Fan speed adjustment outside operating range	Refer to Fan Calibration curve on unit. Adjust speed on PWM Controller to value that will allow motor to start. See instructions for Adjusting EC Motor Speed (pages 4-5).
	Blower Set Screw loose	Tighten Screw onto motor shaft.
	ESP (external static pressure) too high	Verify dampers, if present, are not closed. Verify there are no obstructions in the discharge ductwork and/or at the plenum opening. Verify filter is not dirty and does not obstruct airflow.
Poor performance	Lack of required external static pressure	Add required external static pressure
	Speed adjustment outside fan operating range	Refer to Fan Calibration curve on unit. Adjust speed on PWM Controller to value that will allow motor to start. See instructions for Adjusting EC Motor Speed (pages 4-5).
	Erratic speed command (in Proportional Control mode)	Verify 2-10V analog signal at Remote Control Input terminals.
	Damaged or blocked blower	Verify blower rotates freely. Clear blockage
Motor starts but stops	Voltage or ground loss at motor driver	Verify proper voltage and ground at motor driver power terminals. Refer to Motor Driver Connections for the EC motor.
	Motor overloaded - blower binding	Clear blockage. Verify blower rotates freely with motor disconnected.
	Motor overloaded	Use amp meter to verify motor amps. Verify motor rotates freely with power disconnected. If not, replace motor
	Open ductwork for concealed units	Verify ducts sealed properly
	Motor overheated due to lack of airflow	Verify dampers, if present, are not closed. Verify there are no obstructions in the discharge ductwork and/or at the plenum opening. Verify filter is not dirty and does not obstruct airflow
	PWM board error or faulted	Refer to PWM board status LEDs (page 1). Verify all connections. Push reset button. Replace board if fault returns
	Motor driver failure	Replace motor (Constant airflow or constant torque motors.) Replace driver (Constant RPM motor.)
	Damaged motor cable	Cable is integral to motor, replace motor

Fan Coil EC Motor Control

EC MOTOR TROUBLESHOOTING GUIDELINES

Problem	Possible Cause	Corrective Action
Motor speed cannot be adjusted	PWM board error or faulted	Refer to PWM board status LEDs (page 1). Verify all connections. Push reset button. Replace board if fault returns
	Improper wiring connections	Verify wiring. If Fan Coil Relay board present, verify all jumpers installed.
	EC wiring harness damaged or improperly seated	Unplug harness and re-install, making sure plugs are fully seated. See section on checking wire harnesses, below. Replace harness if damaged.
	No control signal (constant airflow and constant torque)	Constant airflow and constant torque EC motors will run at idle speed if they lose PWM signal while enabled. Verify PWM signal at motor connector by connecting a multimeter set for "duty cycle" between pins 1P1 and 1C (or between pins 2P1 and 2C). The duty cycle represents the on-time percentage signal sent to the motor (this number will vary between the minimum and maximum duty cycle set by the factory). See Figure 1 for PWM board connections (page 1). Refer also to PWM board status LEDs (page 1) to verify board is in normal operating mode
	ESP (external static pressure) too high	Verify dampers, if present, are not closed. Verify there are no obstructions in the discharge ductwork and/or at the plenum opening. Verify filter is not dirty and does not obstruct airflow.
	Motor driver failure	Replace motor (constant airflow or constant torque motors) Replace driver (constant RPM motors)
Motor runs in reverse, doesn't respond to speed adjustment	Motor driver failure	Replace motor (constant airflow or constant torque motors) Replace driver (constant RPM motors)
Excessive motor noise	Motor mounting bolts loose	Tighten motor mounting bolts.
	Motor bearing	Replace motor
	Motor overloaded	Use amp meter to verify motor amps. Verify motor rotates freely with power disconnected. If not, replace motor. Verify static pressure within limits shown on Fan Calibration Curve on unit.
	Fan wheel rubbing on fan housing	Align wheel in housing.
	Loose fan wheel	Align and tighten.
Motor runs in G3 PWM Program mode but not in Run mode	Loose pin in Fixed Speed Conn. harness	Verify that the pins in the Fixed Speed Conn. harness (see location in Figure 1 on Page 1) are inserted fully

Fan Coil EC Motor Control

CHECKING EC WIRE HARNESSES

Use ohmmeter to verify that motor ground wire has continuity from motor case to ground.

To check signal wire harnesses:

Remove power from the unit. Unplug signal harness at EC driver and from motor connector at PWM board.

Use ohmmeter to check continuity for each conductor, then reconnect harnesses to driver and to PWM board.

To check power wire harness:

- Refer to wiring diagram.
- Remove power from the unit. Unplug power harness at EC driver.
- Verify green wire has continuity to ground.
- Unplug power wires from connections in electrical enclosure. Verify continuity of wires to motor driver, then reconnect to same terminals.

Before reconnecting power to unit, verify all harnesses are connected per diagram.

Use light force when inserting meter probe into plug. Excess force will damage contacts.

Fan Coil EC Motor Control

EC MOTOR AND DRIVER

Depending on application, fan coil units can use three control types for EC motors (both single and dual shaft):

- Constant RPM
- Constant Torque
- Constant Airflow

Constant Airflow/Constant Torque EC Motors

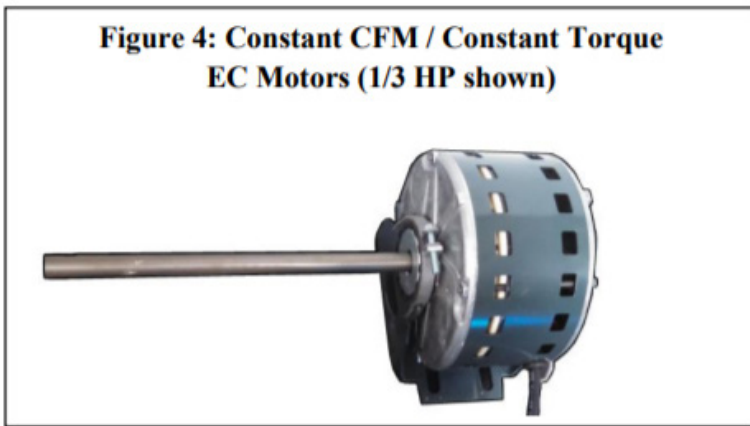

Constant CFM / Constant Torque EC Motor Driver Connections

Note that connections marked (n/u) are not used.

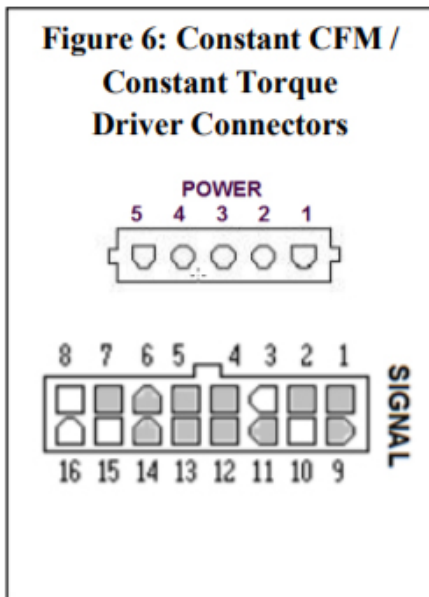

Signal Connector	
Pin	Description
1	C1 (n/u - com)
2	W/W1 (n/u)
3	C2 (PWM COM)
4	DELAY (n/u)
5	COOL (n/u)
6	Y1 (n/u)
7	ADJUST (n/u)
8	OUT-(PWM FB)
9	O (n/u)
10	PWM
11	HEAT (n/u)
12	R (n/u)
13	EM/W2 (n/u)
14	Y/Y2 (n/u)
15	G (Fan Enable)
16	OUT+ (PWM FB)

Power Connector	
Pin	Description
1	Jumper pin 1 to 2 for 120 VAC Line Input only
2	
3	Chassis Ground
4	AC Line (line 1)
5	AC Line (Line 2, Neutral)

Fan Coil EC Motor Control

Constant RPM EC Motors Big Best Manufactured

Figure 7: Constant RPM EC Motor (1/4 HP shown)

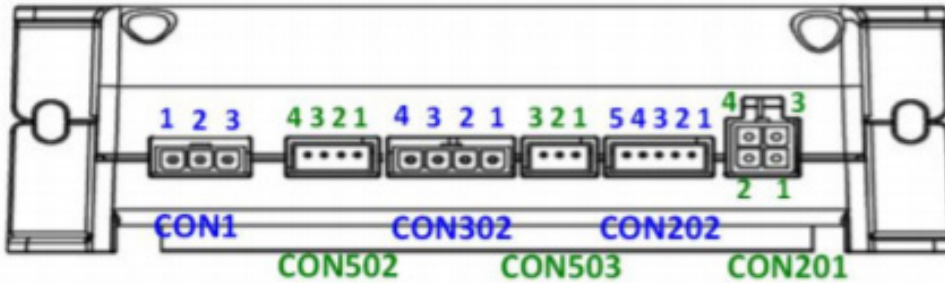

Figure 8: Constant RPM EC Motor Driver



Constant RPM EC Driver Connections

Figure 9: Constant RPM EC Motor Driver Connectors



CON 1, Power Input

Pin	Description
1	Ground
2	Neutral (or Line 2)
3	Line 1

CON 503 (if present) Motor Enable Input

Pin	Description
1	No Connection
2	Signal Input
3	Ground

CON 502 (if present) Programming Connector

Pin	Description
1	+15V
2	Ground
3	TX-
4	TX+

Feedback from EC Motor Hall Sensor

Pin	Description
1	+5V
2	Ground
3	Hall 'W'
4	Hall 'V'
5	Hall 'U'

CON 302, PWM Signal Input

Pin	Description
4	Speed Control Input (H)
3	Speed Control Input (L)
2	Speed Feedback Input (H)
1	Speed Feedback Input (L)

CON 201, Output Power to EC Motor

Pin	Description
1	W1
2	NC
3	V1
4	U1

Fan Coil EC Motor Control

Constant RPM EC Motor Driver Enable Jumper

The Constant RPM EC motor driver (Big Best manufactured) has a Motor Enable Input. These drivers require a jumper across the Enable Connector to allow the unit to operate. See Figure 10 for jumper location across pins 2 and 3 of the Enable Connector.

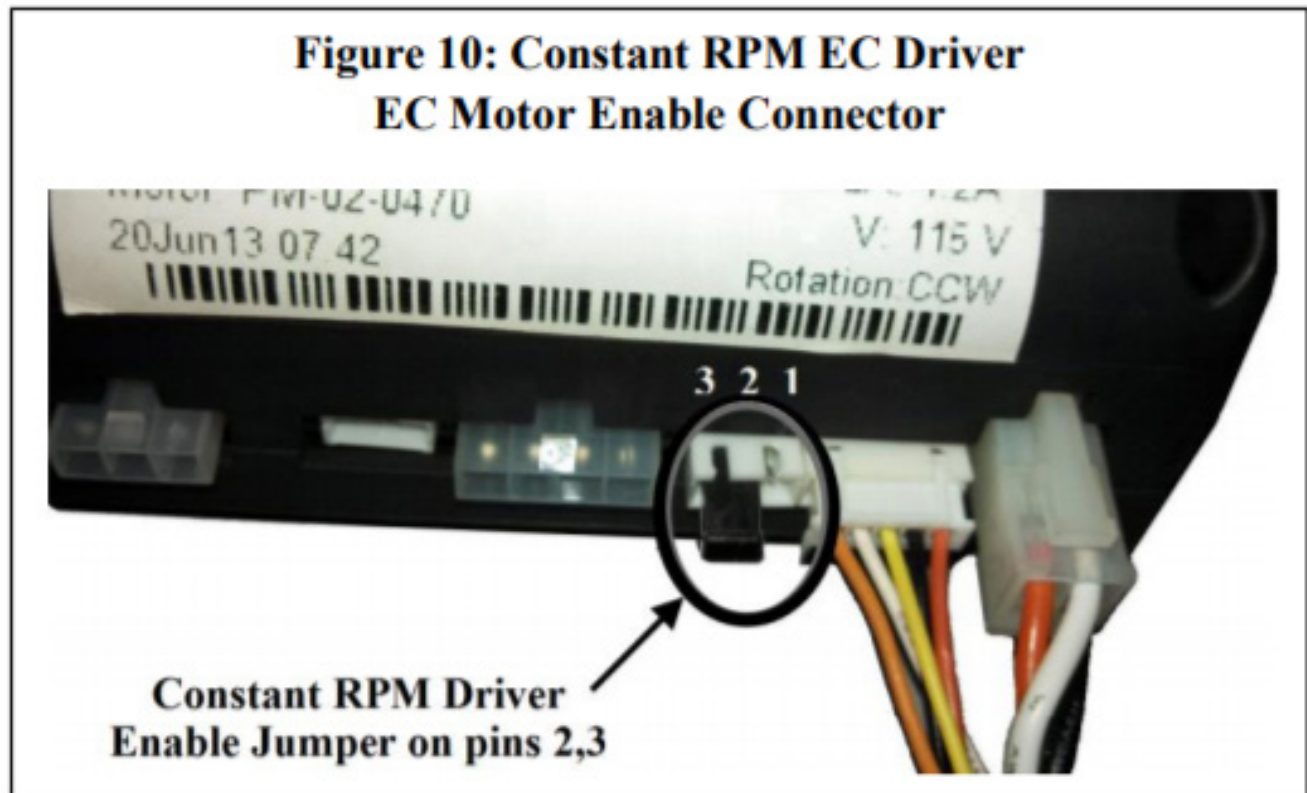

Fan Coil EC Motor Control

Constant RPM EC Motors (Broad Ocean Manufactured)

Figure 11: Constant RPM EC Motor (1/4 HP shown)

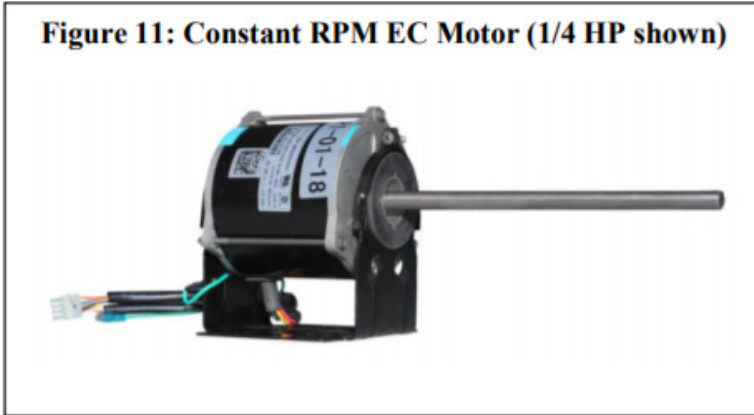
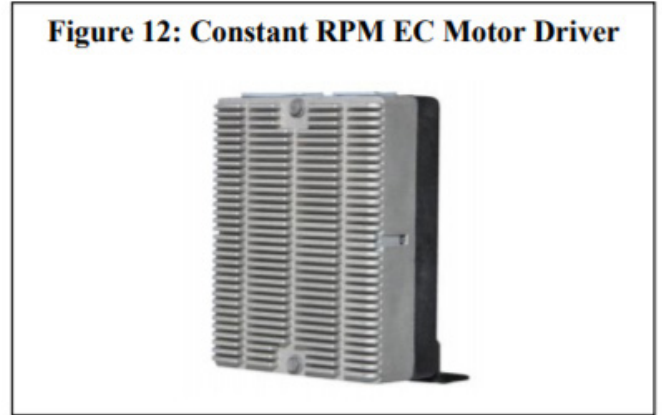
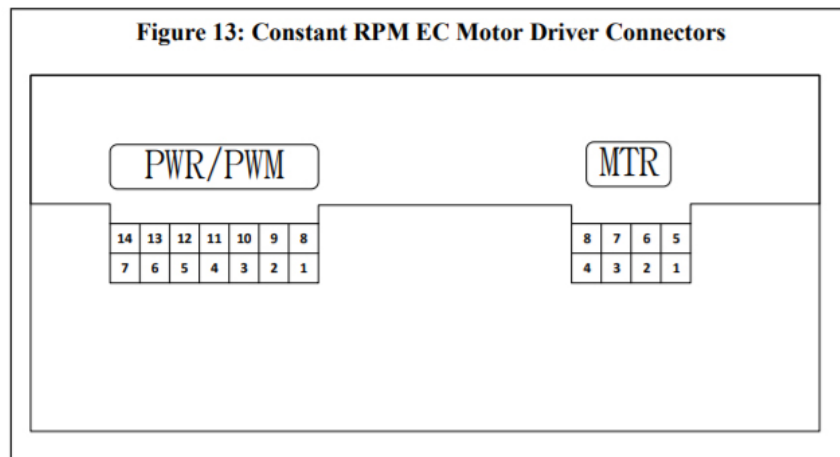

Figure 12: Constant RPM EC Motor Driver



Constant RPM EC Driver Connections

Figure 13: Constant RPM EC Motor Driver Connectors



CON 302, PWM Signal Input

Pin	Description
1	Signal COM
2	-
3	RPM
4	-
5	-
6	-
7	Ground
8	-
9	-
10	PWM
11	Jumper pin 11 to pin 12 for 120 VAC Line Input only
12	
13	Line 1
14	Line 2 / Neutral

MTR Connection

Pin	Description
1	COM
2	HW (Hall Sensor)
3	HV (Hall Sensor)
4	HU (Hall Sensor)
5	W
6	V
7	U
8	+5V